

TF8MHR-042-132I

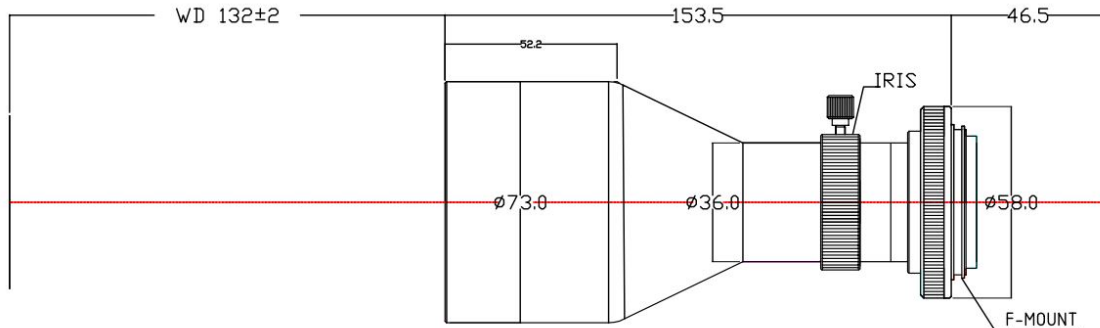

The Object Side Telecentric Lens TF8MHR-042-132I is suitable for sensors up to 8 megapixel and with an image format of 23mm (diagonal).

Technical Data

Art.Gr.	TEL
Magnification	0.42 X
Working Distance (WD)	132 mm
Depth of Field (DOF)	836 µm @CoC 22 µm
Resolution (Object Side)	5.4 µm
Image Format (max.)	23mm (diagonal)
Megapixel (max.)	8 MP
Working F-Number	3.35
Numerical Aperture (NA)	0.0627
Field of View (FOV)	43.2mm x 32.4mm
Telecentric Type	Object Side
Telecentricity	0.03 °
Optical Distortion (max.)	0.03 %
Mount Type	F-Mount

