

TDC-024-108

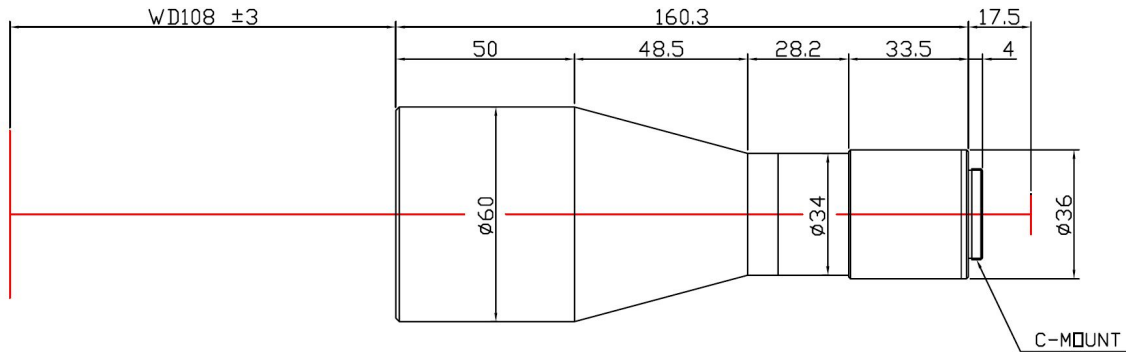

The Double Side Telecentric Lens TDC-024-108 is suitable for sensors with an image format of 2/3 inch.

Technical Data

Art.Gr.	TEL
Magnification	0.24 X
Working Distance (WD)	108 mm
Depth of Field (DOF)	10400 μm @CoC 40 μm
Resolution (Object Side)	21 μm
Image Format (max.)	2/3 inch
Working F-Number	7.5
Numerical Aperture (NA)	0.016
Field of View (FOV)	36.66mm x 27.5mm @ 2/3"
Telecentric Type	Double Side
Telecentricity	0.04 °
Optical Distortion (max.)	0.04 %
Mount Type	C-Mount

