

TC5M-30-65C

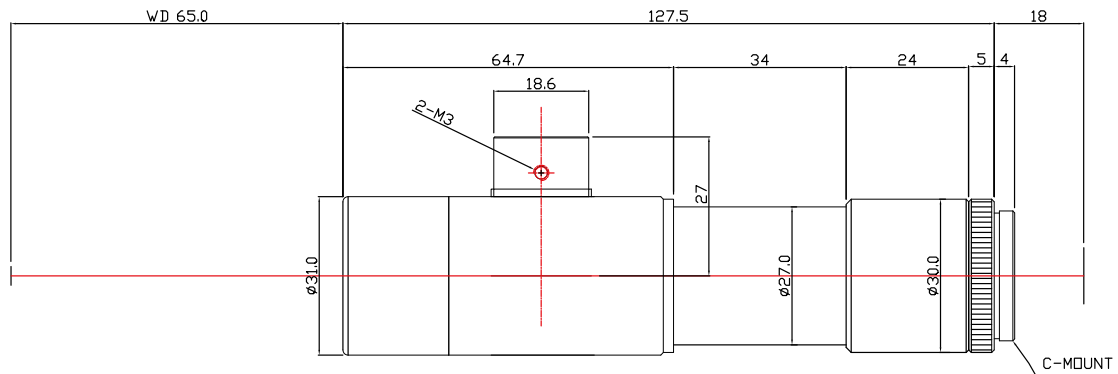

The Object Side Telecentric Lens TC5M-30-65C is suitable for sensors up to 5 megapixel and with an image format of 2/3 inch.

Technical Data

Magnification	3 X
Mount Type	C-Mount
Aperture (F)	9.62
Working Distance (WD)	65
Depth of Field (DOF)	42.7 μm
Resolution (Object Side)	2.15 μm
Numerical Aperture (NA)	0.156
Image Format (max.)	2/3 inch
Megapixel	5 MP
Field of View (FOV)	2.8mm x 2.4mm @5M CCD
Telecentric Type	Object Side
Telecentricity	0.02 °
Optical Distortion (max.)	0.05 %
Special Feature	Super High Res

