

TC4MHR-016-240I

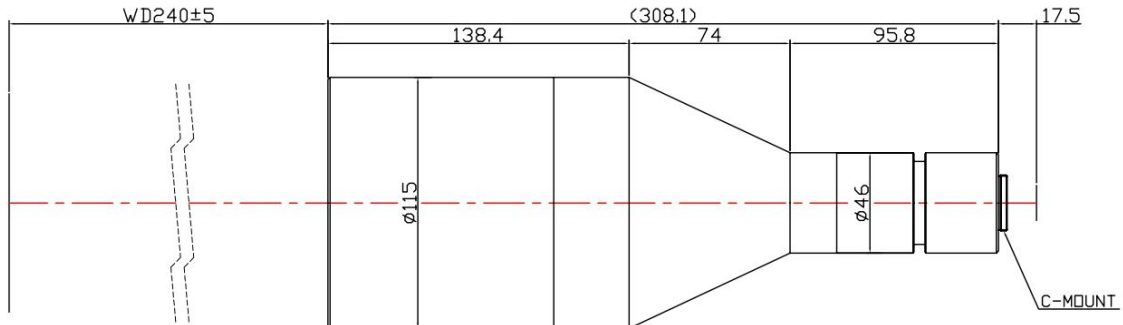

The Object Side Telecentric Lens TC4MHR-016-240I is suitable for sensors up to 4 megapixel and with an image format of 1 inch.

Technical Data

Art.Gr.	TEL
Magnification	0.16 X
Working Distance (WD)	240 mm
Depth of Field (DOF)	12500 μm @CoC 22 μm
Resolution (Object Side)	30.5 μm
Image Format (max.)	1 inch
Megapixel (max.)	4 MP
Working F-Number	7.27
Numerical Aperture (NA)	0.011
Field of View (FOV)	70.4mm x 70.4mm
Telecentric Type	Object Side
Telecentricity	0.03 °
Optical Distortion (max.)	0.01 %
Mount Type	C-Mount

