

TC10M-05-65I

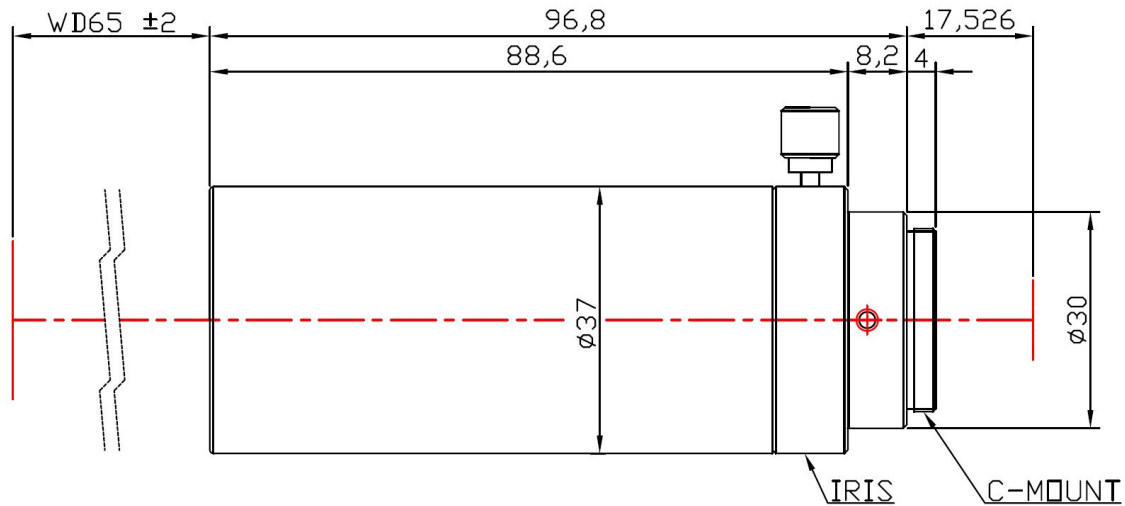

The Object Side Telecentric Lens TC10M-05-65I is suitable for sensors up to 10 megapixel and with an image format of 2/3 inch.

Technical Data

Art.Gr.	TEL
Magnification	0.5 X
Working Distance (WD)	65 mm
Depth of Field (DOF)	1440 μm @CoC 40 μm
Resolution (Object Side)	3.02 μm
Image Format (max.)	2/3 inch
Megapixel (max.)	10 MP
Working F-Number	4.5
Numerical Aperture (NA)	0.0555
Field of View (FOV)	17.6mm x 13.2mm @ 2/3
Telecentric Type	Object Side
Telecentricity	0.04 °
Optical Distortion (max.)	0.03 %
Mount Type	C-Mount

