

T47M-07-117I

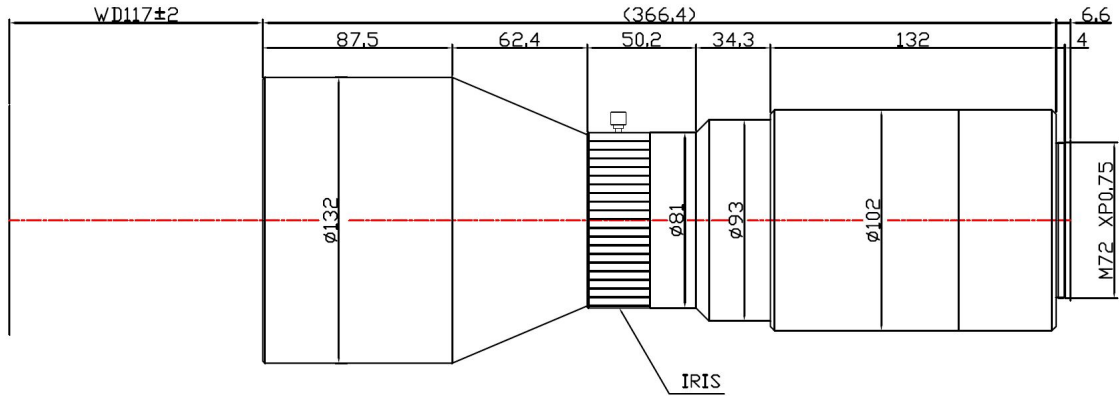

The Object Side Telecentric Lens T47M-07-117I is suitable for sensors up to 47 megapixel and with an image format of 56.7mm (diagonal).

Technical Data

Art.Gr.	TEL
Magnification	0.7 X
Working Distance (WD)	117 mm
Depth of Field (DOF)	718 μm @CoC 22 μm
Resolution (Object Side)	7.7 μm
Image Format (max.)	56.7mm (diagonal)
Megapixel (max.)	47 MP
Working F-Number	8
Numerical Aperture (NA)	0.0437
Field of View (FOV)	69.57mm x 41.42mm
Telecentric Type	Object Side
Telecentricity	0.04 °
Optical Distortion (max.)	0.07 %
Mount Type	M72

