

CMFA3020ND

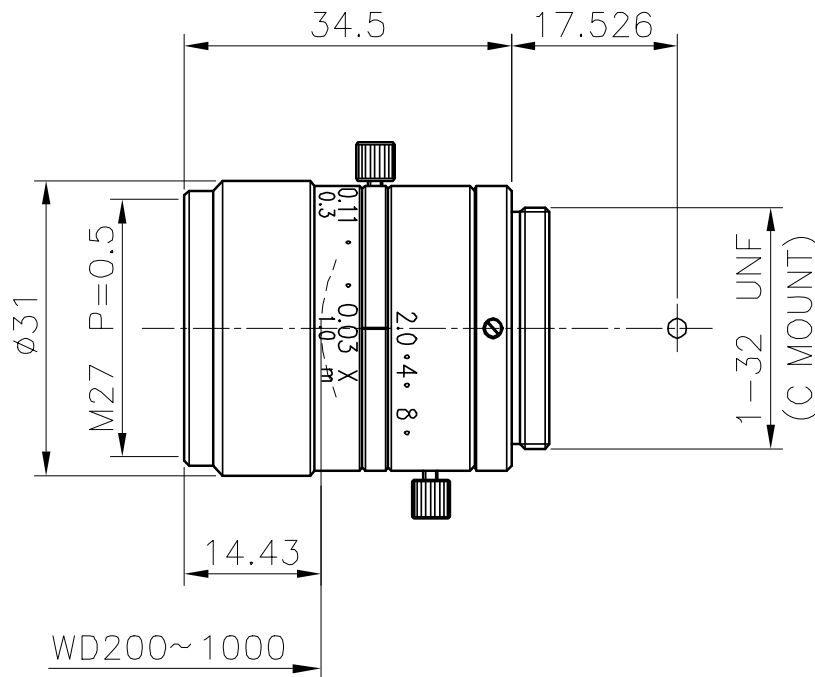

The C-Mount lens Lensagon CMFA3020ND is suitable for common sensors up to 1 megapixel with an image format of 2/3 inch. It is characterized by a particularly high light intensity.

Technical Data

Mount	C-Mount
Sensor	2/3 inch
Focal Length	30 mm
Aperture	2
MOD	0.2 m
max. WD	1 mm
Angle of View	D:20.78° H:16.69° V:12.55°
Megapixel	1-2 MP
IR Correction	No
IR Cut Filter	No
TV Distortion	-0.02 %
Image Circle	11 mm
Weight	59.3 g
Iris	manual-lock
Focus	manual-lock
Filter	M27 P=0.5
Typ	Standard



Light Sensitive

1

Megapixel