

Lensagon BHR8020

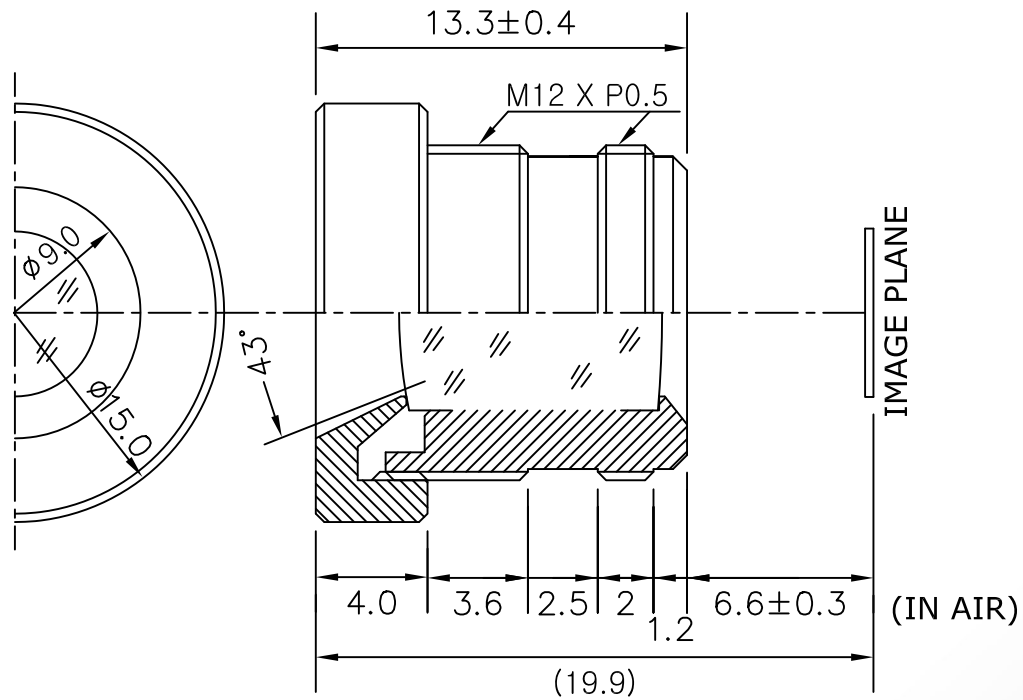

The S-Mount lens Lensagon BHR8020 is suitable for sensors below 1 megapixel with an image format of 1/3 inch. It is characterized by a particularly high light intensity.

Technical Data

Mount	S-Mount
Sensor	1/3 inch
Focal Length	8.00 mm
Aperture	2.00
MOD	0.20 m
Back Focal	7.60 mm
Angle of View	D:43.00° H:33.80° V:25.70°
Megapixel	0.70 MP
IR Cut Filter	No
Weight	4.60 g
Iris	fixed
Focus	fixed
Compatibel	7812



Light Sensitive