

# Lensagon BHR3020

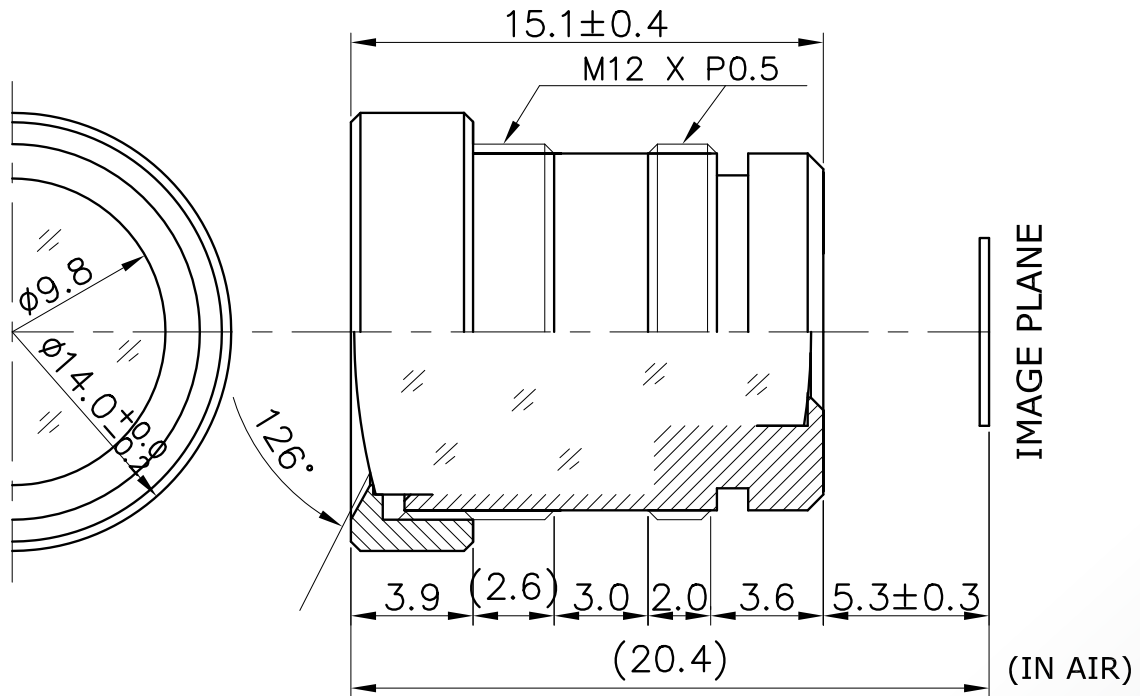

The S-Mount lens Lensagon BHR3020 is suitable for sensors below 1 megapixel with an image format of 1/3 inch. It is characterized by a particularly high light intensity.

## Technical Data

Mount	S-Mount
Sensor	1/3 inch
Focal Length	3 mm
Aperture	2
MOD	0.3 m
Back Focal	5.67 mm
Angle of View	D:126° H:94.4° V:69.5°
Megapixel	0.7 MP
IR Cut Filter	No
Weight	4.4 g
Iris	fixed
Focus	fixed
Typ	Standard



Light Sensitive

